

SAW Learn Mode Water Sensor

Document Number: 466-1539 Rev. C
January 2000

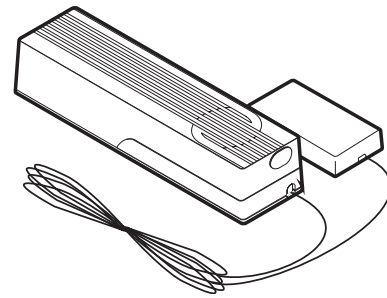

Installation Instructions

Product Summary

The ITI SAW Learn Mode™ Water Sensor detects a water leak in a home or business. The detector is connected to the sensor by an 8-foot (2.4-meter) cable. Water that reaches both detector contact points activates the sensor, causing it to transmit an alarm signal.

The SAW 319.5 MHz transmitter has an operating range of at least 500 feet in open air (depending on panel type and installation environment). The sensor has an estimated battery life of 3 to 5 years.

Tools and Equipment Needed

- Double-sided tape (included) for mounting the detector and sensor
- 1.5-inch wire (used for programming the sensor)
- #6 pan head screws (included) if mounting sensor without double-sided tape is preferred
- Slotted screwdriver (not included) if mounting sensor with screws

Installation Guidelines

This section describes the detector and sensor (transmitter) mounting requirements.

Detector Mounting:

- Install the detector on the floor for low water-level detection or on the bottom of a wall, just above the floor for higher water-level detection.

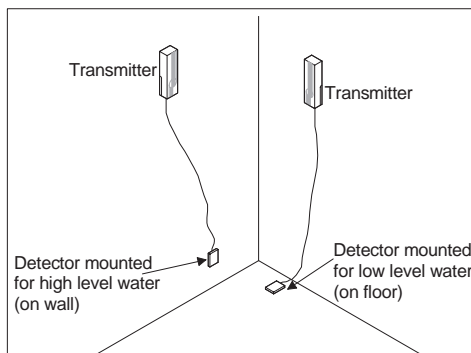

Figure 1. Detector Mounting Options

Note

The contact points on the detector may corrode if exposed to water for more than 24 hours. Instruct your customer to temporarily remove the detector from the water, if possible, during a flood to avoid damaging the detector.

Sensor Mounting:

- Program and test the sensor before mounting.
- Install the sensor where it is easily accessible and not exposed to moisture or extreme temperatures.
- Locate the sensor within 100 feet of the panel whenever possible. Although the sensor has an open-air range of at least 500 feet, the indoor range may be less.

Programming

This section describes how to add (learn) the sensor into the memory of compatible panels.

Simon® Panels

1. Open the control panel cover.
2. Enter Utility Access Code 1 or 2 using the red-numbered buttons.
3. Press Add from the Start Menu.
4. Press the Sensor/Remote button from the Main menu until you hear the location name you wish to use with the sensor. The panel announces the names in the following order:

keychain remote, touchpad remote, front door, back door, garage door, bedroom, guest room, child's room, utility room, living room, dining room, bathroom, laundry room, kitchen, office, den, garage, special chime, basement, upstairs, downstairs, hallway, medicine cabinet, closet, attic.

Each name may be used more than once.

Note

When adding sensors, if you wish to use a more descriptive location you may press the option button to use the compass directions (north, north east, east, south east, south, south west, west, north west).

5. Press DONE.
6. Enter the sensor type number (29) with the red numbered keys.

Note

If you wish to use a sensor number other than the next available, enter a 2-digit sensor number with the red numbered keys immediately after entering the sensor type.

- Remove the sensor outer cover by pressing the cover release button on the end of the transmitter (see Figure 2).

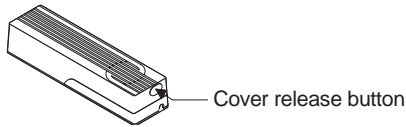

Figure 2. Transmitter Cover Release Button

- Press and hold the “PRESS TO PROGRAM” plastic tab on the sensor until the control panel confirms the programming.

Concord™ and Concord Express™ Panels

The sensor must be in the alarm state for Concord family panels to learn the sensor correctly.

- Remove the sensor outer cover by pressing the cover release button on the end of the transmitter (see Figure 2).
- Short across the detector by wrapping the wire around the two contact points (see Figure 3).

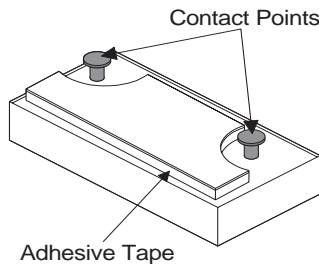

Figure 3. Detector Components (Shown Upside-Down)

- Using an alphanumeric touchpad, enter program mode by pressing **8** + **4** **3** **2** **1** + **0** + **0**. The display shows *SYSTEM PROGRAMMING*.
- Press **Ⓜ** and the display shows *SECURITY*.
- Press **A** or **B** repeatedly until the display shows *SENSORS*.
- Press **Ⓜ** and the display shows *LEARN SENSORS*.
- For panels with partitions, press **Ⓜ** and the display shows *SENSOR PTN 1*.

Press **Ⓜ** to select partition 1 or press **2** + **Ⓜ** to select partition 2.

- The display should now show *SENSOR GROUP 00*. Press **2** + **9** to select sensor group 29, then press **Ⓜ**.
- The display shows *TRIP SENSOR nm*, where *nm* is the next available sensor number. To change the displayed sensor number, select the desired 2-digit sensor number and press **Ⓜ**.

- Press and hold the “PRESS TO PROGRAM” plastic tab on the sensor for at least one full second. The touchpad display should advance to the next available sensor number, indicating the panel learned the Water Sensor.
- Press **Ⓜ** repeatedly until the display shows *SYSTEM PROGRAMMING*.
- Press **A** or **B** until the display shows *EXIT PROGRAMMING*, then press **Ⓜ**.
- Remove the wire from the detector.

Quik Bridge® Loop Receivers

The sensor must be in the alarm state for loop receivers to learn the sensor correctly.

- Remove the sensor outer cover by pressing the cover release button on the end of the transmitter (see Figure 2).
- Short across the detector by wrapping the wire around the two contact points (see Figure 3).
- Enter program mode by sliding the DIP switch up. The low battery and supervisory LEDs blink back and forth. Zone LEDs turn on if sensors are already learned into those zones.
- Press and release the ADV switch until the desired zone LED turns on. (Pressing and holding the ADV switch advances to the next zone and causes the zone LED to flicker.)
- Press and release the SEL switch once to select this zone for learning sensors. The zone LED remains on and the low battery and supervisory LEDs stop flashing.
- Trip the sensor by pressing and holding the “PRESS TO PROGRAM” plastic tab on the sensor for at least one full second. Each time the receiver learns a sensor, the selected zone LED blinks once.
- Exit program mode by sliding the DIP switch back down.
- Remove the wire from the detector.

Testing the Water Sensor

Perform Sensor Test

The following steps describe the general guidelines for testing the sensor. Refer to the specific panel installation instructions or reference manual for complete testing details.

- Place the control panel into dealer sensor test mode.
- Trip the sensor by pressing the “PRESS TO PROGRAM” plastic tab on the sensor (cover removed) until the panel indicates the number of RF packets received.
- Listen for the appropriate siren response as described in the panel installation instructions.

- Exit from dealer sensor test mode.

Test Sensor Operation

- Make sure the Water Sensor is in the secure (non-alarm, dry) state.
- Place the control panel into sensor test mode.
- Trip the sensor by shorting across the detector by wrapping the wire around the two contact points (see Figure 3).
- Listen for the appropriate siren response as described in the panel installation instructions.
- Remove the wire from the two detector contact points to send a restore signal to the panel.
- Exit from sensor test mode.

Installation

Permanently install the Water Sensor only after programming and testing it.

Note

Once the sensor has been installed it is recommended that you test the sensor range.

To install the Water Sensor *without* using screws:

- Prepare a clean, dry mounting surface for the detector and transmitter.
- Secure the *detector* to the mounting surface using the double-faced tape (included).
- Secure the Water Sensor *transmitter* to the mounting surface using the double-faced tape.

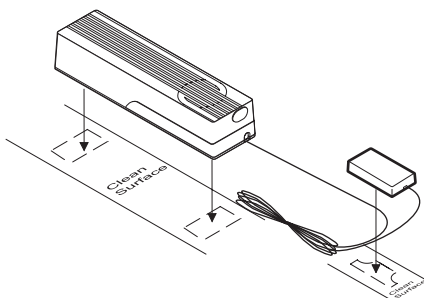

Figure 4. Installing the Water Sensor *without* Screws

To install the Water Sensor using screws:

- Prepare a clean, dry mounting surface for the *detector*.
- Secure the *detector* to the mounting surface using the double-faced tape (included).
- Remove the Water Sensor *transmitter* outer cover by pressing the round button on the end of the transmitter (see Figure 2).
- Remove the batteries from the *transmitter* to access the screw mounting hole underneath them.
- Use the included #6 pan head screws to secure the *transmitter* to the mounting surface. If mounting on plaster, use the appropriate fasteners. Use the slotted mounting hole for alignment (see Figure 5).

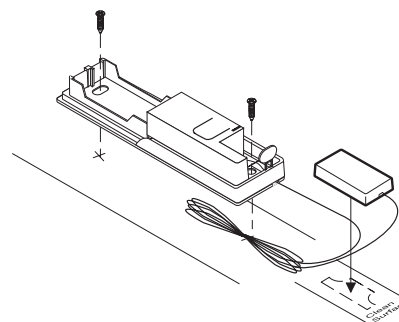

Figure 5. Installing the Water Sensor *with* Screws

- Replace the batteries.
- Replace the transmitter outer cover.

Specifications

Compatibility:	Simon, Concord, Concord Express, Quik Bridge Loop Receiver
Power Source:	Two 1.5 V Alkaline AAA batteries
Temperature Range:	10° to 120° F
Dimensions:	Detector 1.80" x 0.94" x 0.50" (L x W x D) Transmitter 4.5" x 1.13" x 0.94" (L x W x D)

Notices

This device complies with Part 15 of the FCC Rules. Operation is subject to the following two conditions:

This device may not cause harmful interference.

This device must accept any interference that may be received, including interference that may cause undesired operation.

Changes or modifications not expressly approved by Interactive Technologies, Inc. can void the user's authority to operate the equipment.

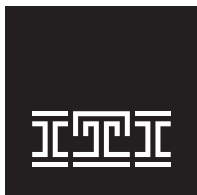

INTERACTIVE TECHNOLOGIES, INC.

2266 SECOND STREET NORTH
NORTH SAINT PAUL, MN 55109

T: 651-777-2690

F: 651-779-4890

W I R E L E S S

Security

Automation

Access Control

ITI, Simon, and Quik Bridge are registered trademarks of Interactive Technologies Inc.

Learn Mode, Concord, and Concord Express are trademarks of Interactive Technologies Inc.